

# SG 5600

---

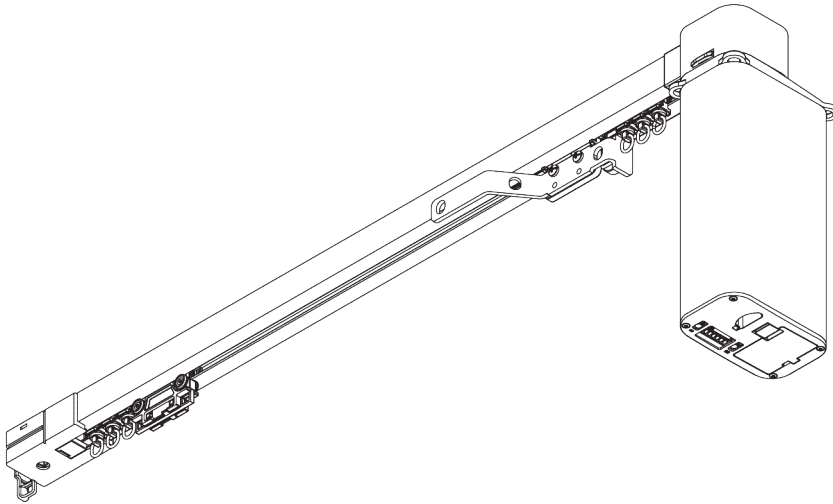
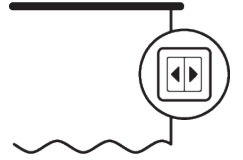

## PRODUKTINFORMATIONEN

- **Bedienung:** Motor
- **Grösse:** S - L
- **Montage:** Decke, Wand, Nut
- **Farben:** weiss RAL 9016, schwarz RAL 9005 oder Aluminium farblos eloxiert, Sonderfarben möglich (Nutprofil nur weiss RAL 9016, schwarz RAL 9005 oder Sonderfarbe)
- **Stoffe:** siehe Silent Gliss Stoffkollektion

### **Merkmale:**

- Leiser, schneller und kraftvoller Motor
- 2-Komponenten-Roller-Technologie (2C)
- Wave (2C)
- Vielfältige Steuerungsmöglichkeiten
- Touch & Go
- Manual Override inklusive permanentem Positionssensor
- Einfache Programmierung
- 100-250 AC und / oder 24 V DC in einem Motor
- Biegsam
- Biegsames Nutprofil

# SYSTEMSPEZIFIKATIONEN

## A. MASSE / GEWICHT

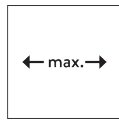

25 m



65 kg

### Max. Vorhanggewicht mit 2C-Roller / Wave-2C-Rollerkordel

Touch & Go, Manual Override, automatischer Programmiermodus bis zu 12 m.

	2 m	4 m	6 m	8 m	10 m	12 m	15 m	18 m	21 m	25 m
	25	45	45	50	65	45	45	45	45	40
	25	45	45	50	65	45	45	45	45	40
	25	35	35	40	35	35	35	32	29	25
	25	35	35	40	35	35	35	32	29	25
	25	30	30	30	25	25	22	19	15	-
	25	30	30	30	25	25	22	19	15	-
	20	20	20	18	16	12	10	-	-	-
	20	20	20	18	16	12	10	-	-	-

(kg max.)

### Max. Vorhanggewicht mit Wave Gleiterkordel oder Gleiter

	2 m	4 m	6 m	8 m	10 m
	20	25	25	25	20
	20	25	25	25	20
	20	20	20	20	15
	20	20	20	20	15
	20	20	20	15	10
	20	20	20	15	10
	20	20	15	8	-
	20	20	15	8	-

(kg max.)

## B. PROFIL

### Profil- und Biegeinformationen

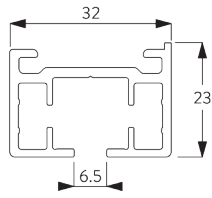

**SG 10850**

Profil

Radius: >25 cm

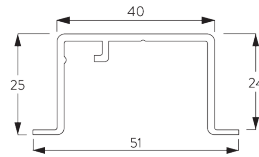

**SG 10862**

Nutprofil

Radius: 50 - 75 cm  
>75 cm auf Anfrage

## C. MASSAUFNAHME

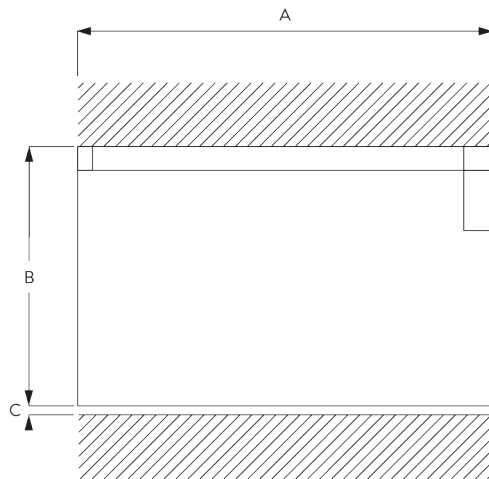

A: Systembreite

B: Systemhöhe

C: Abstand zwischen Boden und Behang

# MONTAGE

## A. MONTAGE- INFORMATIONEN

Detaillierte Montageinformationen siehe  
Silent Gliss Website

### Montagepunkte

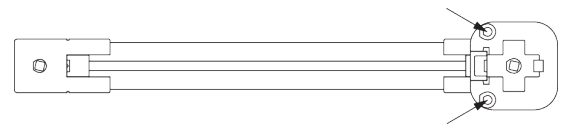
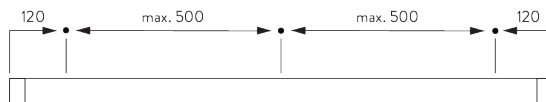

Motormaske zu fixieren (nur Deckenmontage).

## B. DECKEN- MONTAGE

### Spanner SG 3004

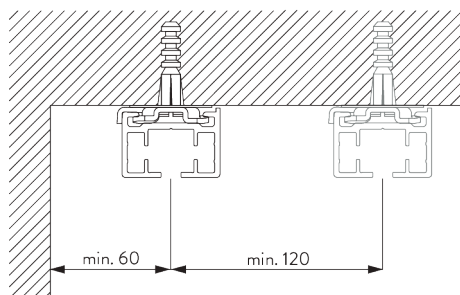

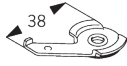

**SG 3004**  
Spanner

**Direkte Montage (nur 2C-Roller)**

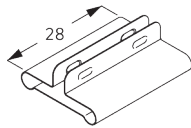
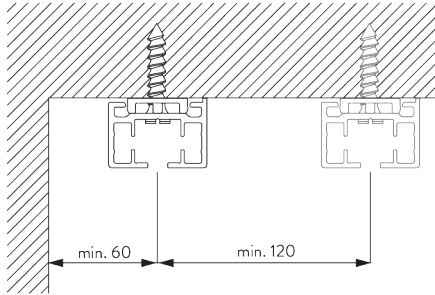

**SG 7002**  
Profilschutz

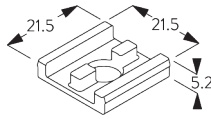

**SG 10865**  
Montageplatte

**C. WANDMONTAGE**

**Smart Fix**

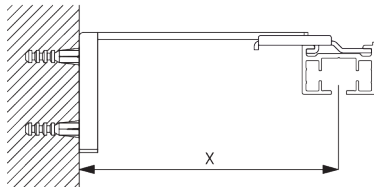

**Smart Fix SG 11200 - SG 11205 und Träger SG 3041:**  
Benötigt Schraube SG 10492 (M4x8).

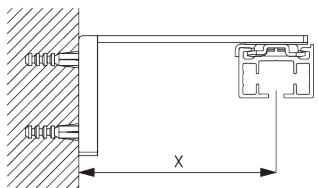

**Smart Fix SG 11200 - SG 11205 und Spanner SG 3004:**  
Benötigt Schraube SG 10074 (M4x8).

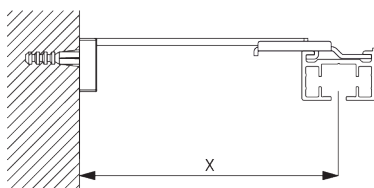

**Square Smart Fix SG 11210 - SG 11215 und Träger SG 3041:**  
Benötigt Schraube SG 10492 (M4x8).

Smart Fix	X mm (SG 3041)	X mm (SG 3004)
SG 11200 / SG 11210	83	
SG 11201 / SG 11211	103	72
SG 11202 / SG 11212	123	92
SG 11203 / SG 11213	143	112
SG 11204 / SG 11214	173	142
SG 11205 / SG 11215	223	192
SG 11154	128-156	102-130
SG 11155	158-186	132-160
SG 11156	208-236	182-210

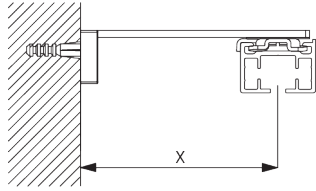

**Square Smart Fix SG 11210 - SG 11215 und Spanner SG 3004:**

Benötigt Schraube SG 10074 (M4x8).

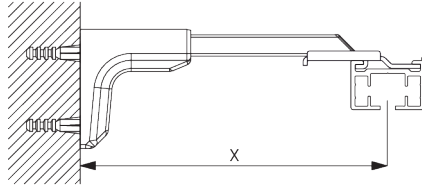

**Universal Smart Fix SG 11154 - SG 11156 und Träger SG 3041:**

Benötigt Schraube SG 10407 (M4x10).

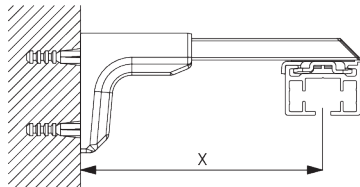

**Universal Smart Fix SG 11154 - SG 11156 und Spanner SG 3004:**

Benötigt Schraube SG 11158 (M4x12).

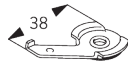

**SG 3004**  
Spanner

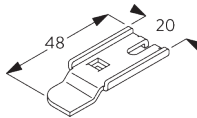

**SG 3041**  
Träger



**SG 10074**  
Senkschraube M4x8



**SG 10407**  
Linsenschraube M4x10



**SG 10492**  
Linsenschraube M4x8



**SG 11158**  
Senkschraube M4x12

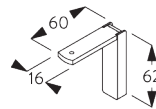

**SG 11200**  
Smart Fix 60 mm

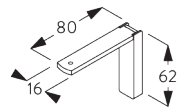

**SG 11201**  
Smart Fix 80 mm

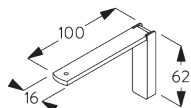

**SG 11202**  
Smart Fix 100 mm

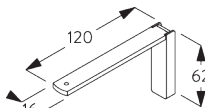

**SG 11203**  
Smart Fix 120 mm

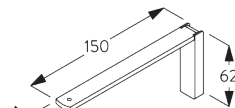

**SG 11204**  
Smart Fix 150 mm

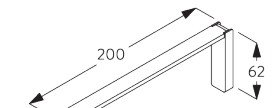

**SG 11205**  
Smart Fix 200 mm

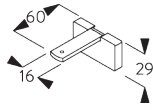

**SG 11210**  
Square Smart Fix 60 mm

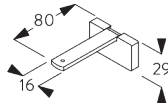

**SG 11211**  
Square Smart Fix 80 mm

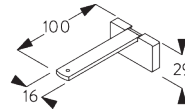

**SG 11212**  
Square Smart Fix 100 mm

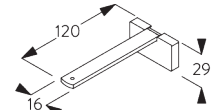

**SG 11213**  
Square Smart Fix 120 mm

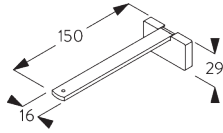

**SG 11214**  
Square Smart Fix 150 mm

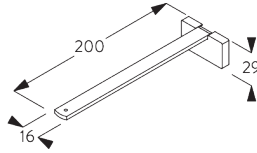

**SG 11215**  
Square Smart Fix 200 mm

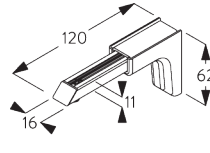

**SG 11154**  
Universal Smart Fix 120 mm

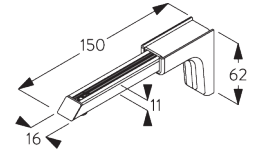

**SG 11155**  
Universal Smart Fix 150 mm

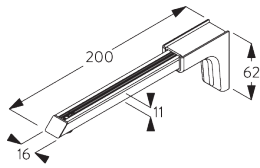

**SG 11156**  
Universal Smart Fix 200 mm

## D. NUTMONTAGE

### Nutprofil SG 10862

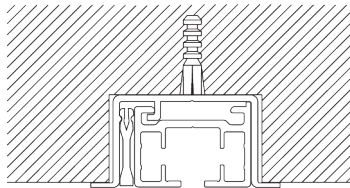

Eine Klammer SG 5118 pro Montagepunkt.

Detaillierte Nutmontage siehe Silent Gliss Website.

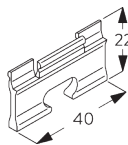

**SG 5118**  
Klammer

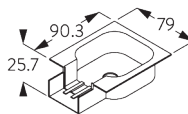

**SG 10863**  
Nutmaske Motor

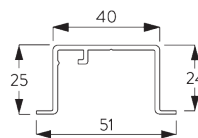

**SG 10862**  
Nutprofil

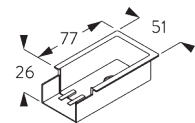

**SG 10864**  
Nutmaske

## Hohldecke

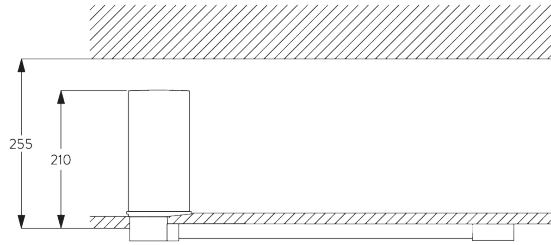

Profil mit Spanner SG 3004 montiert.

Für Montage / Programmierung ist Zugang zum Hohlraum notwendig.

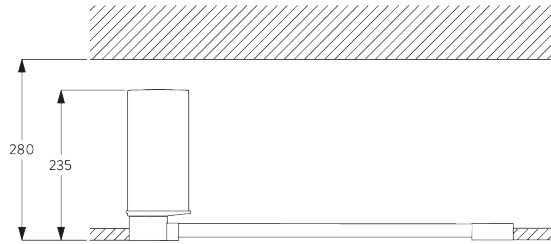

Nutprofil SG 10862 eingebaut.

Für Montage / Programmierung ist Zugang zum Hohlraum notwendig.

## E. ABGEHÄNGTE MONTAGE

### Hänger SG 6105

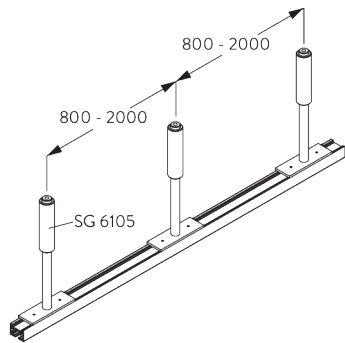

Das Gewicht des Vorhangs reduziert sich um 30 %.

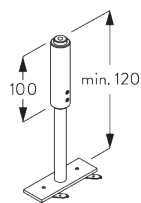

**SG 6105**

Hänger

## V-Hänger SG 6107

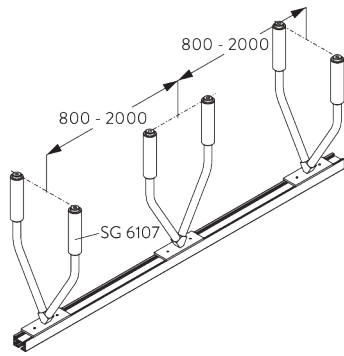

Das Gewicht des Vorhangs reduziert sich um 30 %.

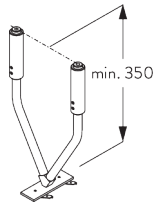

**SG 6107**  
V-Hänger

# SYSTEMOPTIONEN

## A. WAVE

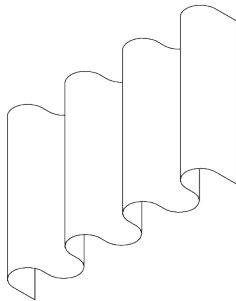

SG 6365



SG 10844

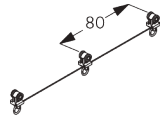

SG 10852



SG 10854



SG 10856



SG 10867



SG 10886



SG 10887

### Standard Komponenten:

- SG 6365 Wave Hänger
- SG 10844 Wave Feststeller
- SG 10852 Wave-2C-Rollerkordel 80 mm
- SG 10854 Wave Vorläufer
- SG 10856 Wave Endstop
- SG 10867 Schraube
- SG 10886 Wave Überzugwagen
- SG 10887 Wave Überzugwagen



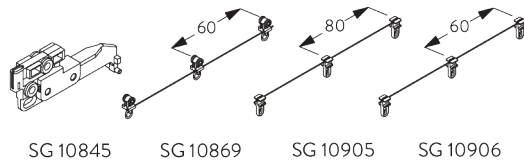

SG 10845 SG 10869 SG 10905 SG 10906

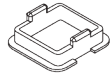

SG 10924

**Optionale Komponenten:**

- SG 10845 Wave Vorläufer 80 mm
- SG 10869 Wave-2C-Rollerkordel 60 mm (nicht 1-teilig)
- SG 10905 Wave Gleiterkordel 80 mm
- SG 10906 Wave Gleiterkordel 60 mm (nicht 1-teilig)
- SG 10924 Wave Feststeller

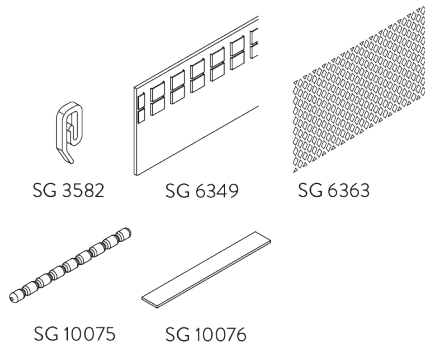

SG 3582 SG 6349 SG 6363  
SG 10075 SG 10076

**Vorhang Komponenten:**

- SG 3582 Haken
- SG 6349 Wave Vorhangband
- SG 6363 Wave Bügelband
- SG 10075 Bleischnur 50 gr/m
- SG 10076 Beschwerung Seitensaum

**Wave Paketbreite - 2C-Roller- / Gleiterkordel (Standard Komponenten)**

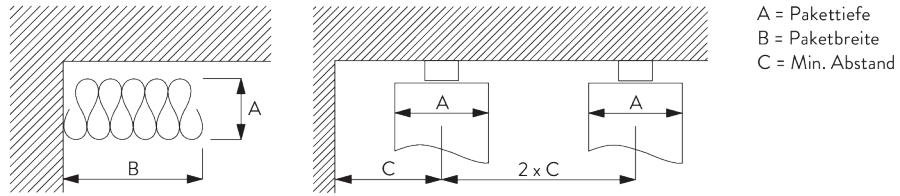

A = Pakettiefe  
B = Paketbreite  
C = Min. Abstand

Roller-/ Gleiterkordel SG 10852 / 10905	Zwischen- laschen	Stoffzugabe	Pakettiefe A	Paketbreite B*	Min. Abstand C
80	6	~2.1	140	210 pro Meter System	90
80	7	~2.3	160	210 pro Meter System	100

Roller-/ Gleiterkordel SG 10869 / 10906	Zwischen- laschen	Stoffzugabe	Pakettiefe A	Paketbreite B*	Min. Abstand C
60	4	~2.1	100	260 pro Meter System	70
60	5	~2.3	120	260 pro Meter System	80

\*Paketgröße B plus 190 mm pro Vorhangpaket!

# MOTOREN UND BEDIENUNGSARTEN

## A. MOTOR- MERKMALE

Motor	SG 9060
<b>Motoreigenschaften</b>	
Soft-Start / Stop	•
Touch & Go	•
Manual Override	•
Modularer Funkempfänger (optional)	•
Elektronische Endposition	•
Elektronischer Umdrehungszähler (Umdrehungszahl unbegrenzt)	•
Zwei Zwischenpositionen möglich	•
Parallelschaltung möglich ohne zusätzliche Relais	•
High-end DC Motor mit bürstenloser Technologie	•
Permanenter Positionssensor (auch ohne Strom)	•
100 - 250 V AC und / oder 24 V DC in einem Motor	•
Anschlusskabel an Motor ansteckbar	•
IP Klasse	IP 40
<b>Steuerungsmöglichkeiten</b>	
Netzstrom	•
Potenzialfreie Kontakte	•
Potenzialfreie Kontakte kombinierbar mit SG Control L	•
SG Control L (mit Funkempfänger)	•
Smart by Silent Gliss (mit Smart Modul)	•
Geeignet für alle gängigen Hausautomationssysteme (mit passender Schnittstelle)	•

## B. MOTOR- SPEZIFIKATIONEN

Motor	Motorabmessungen	Spannung AC	Spannung DC	Stromstärke	Frequenz	Geschwindigkeit / Sek.	Funkfrequenz Empfänger
SG 9060	L 206 x H 60 x T 96	100 - 250 V AC	24 V DC	1.3 - 0.5 A	50 - 60 Hz	21 cm / Sek.	-
SG 9060 mit SG Control L	L 226 x H 60 x T 96	100 - 250 V AC	24 V DC	1.3 - 0.5 A	50 - 60 Hz	21 cm / Sek.	868/915 MHz
SG 9060 mit Smart by SG	L 226 x W 60 x D 96	100 - 250 V AC	24 V DC	1.3 - 0.5 A	50 - 60 Hz	21 cm / Sek.	Smart by SG

Siehe Website für  
Schaltschema.

## C. FUNK- EMPFÄNGER

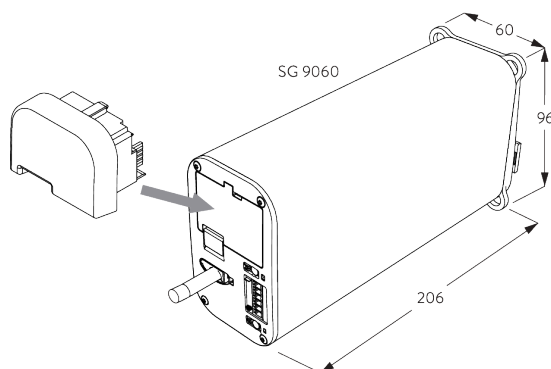

Motor SG 9060 kann mit folgendem Funkempfänger ausgestattet werden:

- SG 9063 Funkmodul
- SG 11270 Smart Modul

Siehe Katalog "Steuerungen".

## D. BEDIENUNGS- ARTEN

Siehe Katalog "Steuerungen" für mehr Details.

Wandschalter



Bedienbar mit drahtgebundenem Wandschalter.

SG Control L



Verschiedene Funkfernsteuerungen erhältlich.



Silent Gliss Move App.

Smart by Silent Gliss



Offenes Zwei-Weg-Kommunikationssystem, das eine problemlose Integration der Produkte mit den meisten gängigen Gebäudemanagementsystemen ermöglicht. Smart-Modul SG 11270 erforderlich.

## E. SCHALTSCHHEMA



Siehe Silent Gliss Website.

# KOMPONENTEN

## A. STANDARD KOMPONENTEN

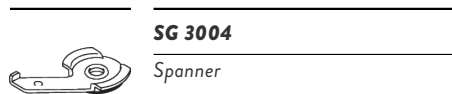

**SG 3004**

Spanner

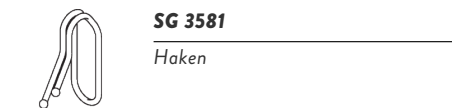

**SG 3581**

Haken

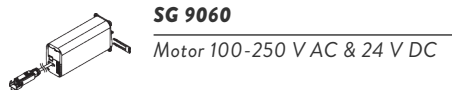

**SG 9060**

Motor 100-250 V AC & 24 V DC



**SG 9917**

Hirschmann Kupplung STAK 3 N

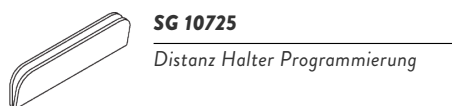

**SG 10725**

Distanz Halter Programmierung



**SG 10815**

Abdeckung



**SG 10816**

Motorabdeckung



**SG 10817**

Motorhalterung

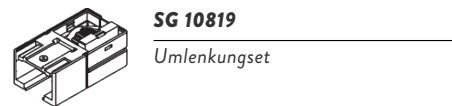

**SG 10819**

Umlenkungset

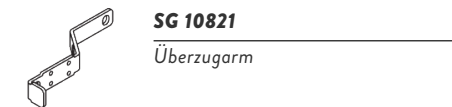

**SG 10821**

Überzugarm



**SG 10822**

Mitnehmerset

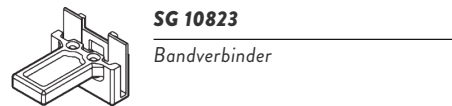

**SG 10823**

Bandverbinder

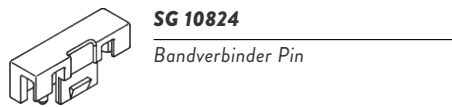

**SG 10824**

Bandverbinder Pin

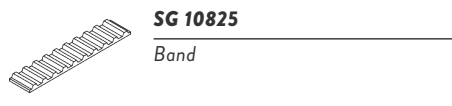

**SG 10825**

Band

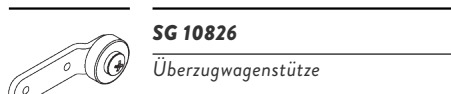

**SG 10826**

Überzugwagenstütze

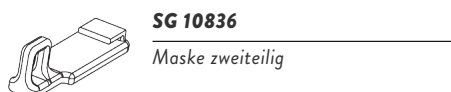

**SG 10836**

Maske zweiteilig

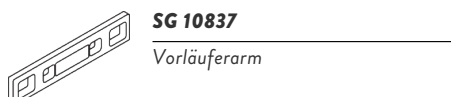

**SG 10837**

Vorläuferarm



**SG 10838**

Vorläuferset

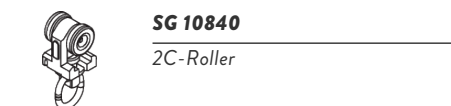

**SG 10840**

2C-Roller

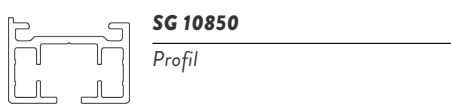

**SG 10850**

Profil

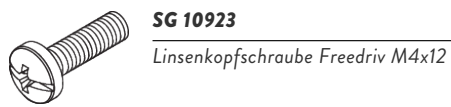

**SG 10923**

Linsenkopfschraube Freedriv M4x12

## B. OPTIONALE KOMPONENTEN



**SG 3012**

Haken

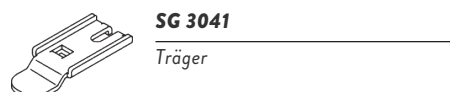

**SG 3041**

Träger



**SG 3582**

Haken



**SG 5118**

Klammer

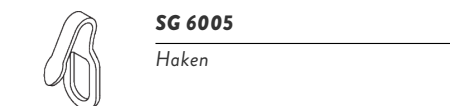

**SG 6005**

Haken



**SG 6105**

Hänger

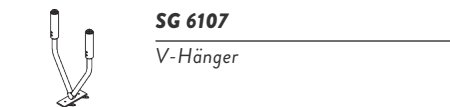

**SG 6107**

V-Hänger



**SG 6349**

Wave Vorhangband



**SG 6363**

Wave Bügelband



**SG 6365**

Wave Hänger



**SG 7002**

Profilschutz

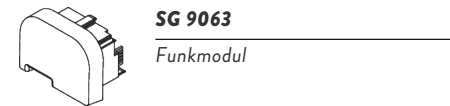

**SG 9063**

Funkmodul



**SG 9916**

Hirschmann Kupplungsset

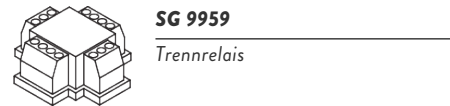

**SG 9959**

Trennrelais

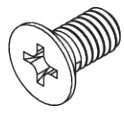

**SG 10074**  
Senkschraube M4x8



**SG 10075**  
Bleischnur 50 gr/m

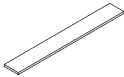

**SG 10076**  
Beschwerung Seitensaum

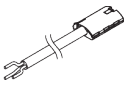

**SG 10293**  
Anschlusskabel 230V AC, 2/3/5/10 m



**SG 10300**  
Funkhandsender 1-Kanal



**SG 10302**  
Funkhandsender 5+1-Kanal

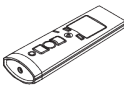

**SG 10303**  
Funkhandsender 10+2+1-Kanal

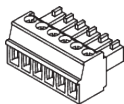

**SG 10714**  
Stecker 6-pin, MC 1.5/6-ST-3.81



**SG 10804**  
Funkhandsender 15+5+1 Kanal

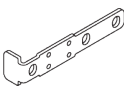

**SG 10820**  
Überzugarm



**SG 10831**  
Profilverbinder

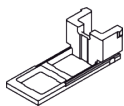

**SG 10844**  
Endposition Motor

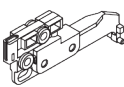

**SG 10845**  
Wave Mitnehmer 80 mm

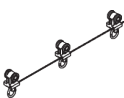

**SG 10852**  
Wave-2C-Rollerkordel 80 mm

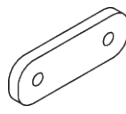

**SG 10854**  
Wave Überzugwagenplatte

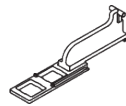

**SG 10856**  
Wave Verlängerung

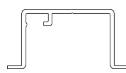

**SG 10862**  
Nutprofil

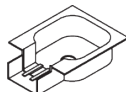

**SG 10863**  
Nutmaske Motor

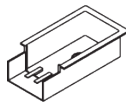

**SG 10864**  
Nutmaske

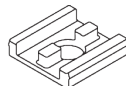

**SG 10865**  
Montageplatte

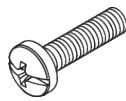

**SG 10867**  
Linsenschraube Freedriv M4x16

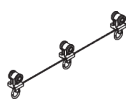

**SG 10869**  
Wave-2C-Rollerkordel 60 mm

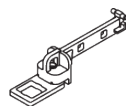

**SG 10886**  
Wave Verlängerung

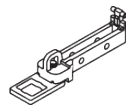

**SG 10887**  
Wave Verlängerung

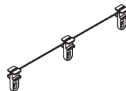

**SG 10905**  
Wave Gleiterkordel 80 mm

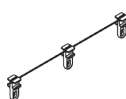

**SG 10906**  
Wave Gleiterkordel 60 mm

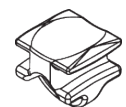

**SG 10921**  
Gleiter für direktes Annähen

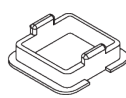

**SG 10924**  
Wave Gleitersupport

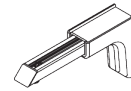

**SG 11154**  
Universal Smart Fix 120 mm

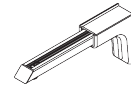

**SG 11155**  
Universal Smart Fix 150 mm

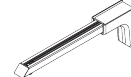

**SG 11156**  
Universal Smart Fix 200 mm

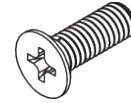

**SG 11158**  
Senkschraube M4x12

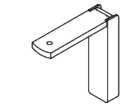

**SG 11200**  
Smart Fix 60 mm

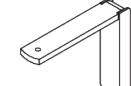

**SG 11201**  
Smart Fix 80 mm

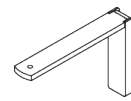

**SG 11202**  
Smart Fix 100 mm

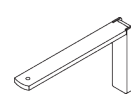

**SG 11203**  
Smart Fix 120 mm

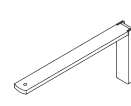

**SG 11204**  
Smart Fix 150 mm

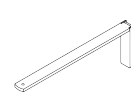

**SG 11205**  
Smart Fix 200 mm

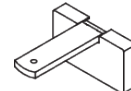

**SG 11210**  
Square Smart Fix 60 mm

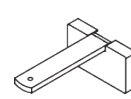

**SG 11211**  
Square Smart Fix 80 mm

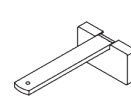

**SG 11212**  
Square Smart Fix 100 mm

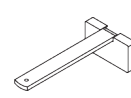

**SG 11213**  
Square Smart Fix 120 mm

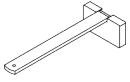
**SG 11214**

Square Smart Fix 150 mm

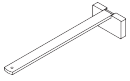
**SG 11215**

Square Smart Fix 200 mm

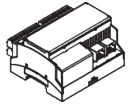
**SG 11260**

Gateway Cedia

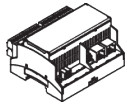
**SG 11261**

Gateway KNX

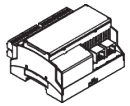
**SG 11262**

Erweiterung

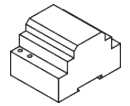
**SG 11264**

Transformer 24V DC, 3.8 Ampere  
DIN Rail

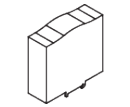
**SG 11265**

Transformer 24V DC, 5 Ampere  
DIN Rail

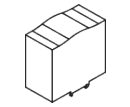
**SG 11266**

Transformer 24V DC, 10 Ampere  
DIN Rail

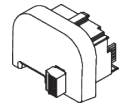
**SG 11270**

Smart Modul

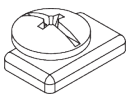
**SG 11295**

Feststeller

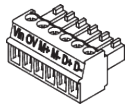
**SG 11325**

Smart Stecker 6-Polig

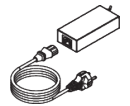
**SG 11414**

Netzteil 24V / 4A C 13 inkl. Kabel  
mit EU Stecker

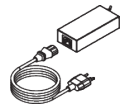
**SG 11415**

Netzteil 24V / 4A C 13 inkl. Kabel  
mit CH Stecker

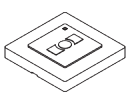
**SG 11480**

Funkwandsender 1-Kanal

**SG 11490**

Funkwandsender 5+1-Kanal



